

## Embedded Solutions



## PCIe M.2 SSDs **MTE550T**

Transcend's MTE550T M.2 SSD is a SSD solution utilizing the PCI Express (PCIe) Gen 3 x4 interface, and is fully compatible with NVM Express (NVMe) 1.3 specifications. The next-generation PCIe NVMe protocol allows the SSD to achieve never-before-seen transfer speeds. The cost-effective MTE550T aims at high-end applications, such as digital audio/video production, gaming, and enterprise use at an attractive price. Powered by 64-layer 3D NAND TLC flash memory and built with DRAM cache, the MTE550T offers not only outstanding 4K random read and write performance but unmatched reliability.

### Features

- PCIe Gen 3 x4 interface
- Compliant with PCI Express specification Rev. 3.1
- Compliant with NVM Express specification Rev. 1.3
- SLC caching technology
- LDPC ECC algorithm
- Dynamic thermal throttling
- RoHS compliant
- Supports Transcend SSD Scope

### Ordering Information

128GB	TS128GMTE550T
256GB	TS256GMTE550T

## Specifications

Appearance	Dimensions (Max.)	80 mm x 22 mm x 3.58 mm (3.15" x 0.87" x 0.14")
	Weight (Max.)	8 g (0.28 oz)
	Form Factor	M.2
	M.2 Type	2280-D2-M
Interface	Bus Interface	NVMe PCIe Gen3 x4
Storage	Flash Type	3D TLC NAND flash
	Capacity	128 GB/256 GB
Operating Environment	Operating Voltage	3.3V±5%
	Operating Temperature	0°C (32°F) ~ 70°C (158°F)
	Storage Temperature	-40°C (-40°F) ~ 85°C (185°F)
	Humidity	0% ~ 95%
	Shock	1500 G, 0.5 ms, 3 axis
	Vibration (Operating)	3 G (peak-to-peak), 5 Hz ~ 800 Hz (frequency)
Power	Vibration (Non-operating)	5 G (peak-to-peak), 5 Hz ~ 800 Hz (frequency)
	Power Consumption (Operation)	4 watt(s)
Performance	Power Consumption (Sleep)	0.6 watt(s)
	Sequential Read/Write (ATTO, max.)	Read: 1800 MB/s; write: 800 MB/s
	Sequential Read/Write (CrystalDiskMark, max.)	Read: 1800 MB/s; write: 800 MB/s
	4K Random Read/Write (IOMeter, max.)	Read: 142,000 IOPS; write: 134,000 IOPS
	Mean Time Between Failures (MTBF)	1,500,000 hour(s)
	Drive Writes Per Day (DWPD)	180 TB
	DWPD	0.66 (3 yrs)
Certificate	CE/FCC/BSMI	
Warranty	Warranty	Three-year Limited Warranty
Note	<ul style="list-style-type: none"> <li>Speed may vary due to host hardware, software, usage, and storage capacity.</li> <li>The workload used to rate DWPD may be different from your actual workload, which may vary due to host hardware, software, usage, and storage capacity.</li> </ul>	

## Mechanical Dimensions

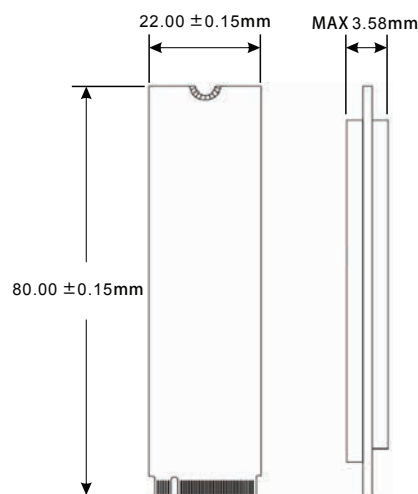

Product specifications are subject to change without notice. Pictures shown may differ from actual products. Total accessible capacity varies depending on operating environment. Due to the complexity and variety of industrial applications, Transcend cannot guarantee 100% compatibility with all platforms and under all scenarios. For special applications and environments, it is strongly suggested that you contact Transcend beforehand for clarification.



Please feel free to contact us with any special requests you might have.

Tel: +886-2-2792-8000 [www.transcend-info.com](http://www.transcend-info.com)

