

Embedded Solutions

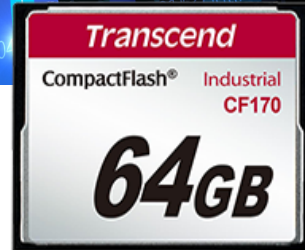

CompactFlash Cards CF170

Boasting a high-speed data transfer rate and extra large capacity, Transcend's industrial CF170 CompactFlash cards are perfect for embedded systems, medical instruments, road surveillance systems, and other industrial applications having high performance and capacity demands. Thanks to their use of Static Data Refresh and Early Retirement technology, CF170 CF cards feature error correction capability, maintain data integrity, and have an extended lifespan.

Hardware Features

- Compliant with RoHS 2.0 standards
- Compliant with CompactFlash specification 6.0
- Durability: 10,000 insertion/removal cycles
- Intelligent Power Shield (IPS) to prevent data loss in the event of sudden power outage

Ordering Information

8GB	TS8GCF170
16GB	TS16GCF170
32GB	TS32GCF170
64GB	TS64GCF170

Firmware Features

- Enhanced S.M.A.R.T. function for durability
- Wear-Leveling
- Security Command
- Static Data Refresh
- Early Retirement

Specifications

Appearance	Dimensions	42.8 mm x 36.4 mm x 3.3 mm (1.69" x 1.43" x 0.13")
	Pin Count	50 pin
	Form Factor	Compact flash card
Storage	Flash Type	MLC NAND flash
	Capacity	8 GB / 16 GB / 32 GB / 64 GB
Operating Environment	Operating Voltage	3.3V±5% 5V±10%
	Operating Temperature	-25°C (-13°F) ~ 85°C (185°F)
	Storage Temperature	-40°C (-40°F) ~ 85°C (185°F)
	Humidity	0% ~ 95%
	Shock	Acceleration: 490 m/s ² (standard holding time: 11 ms, semi-sine wave, velocity change: 3.44 m/s)
	Vibration (Operating)	20 G (peak-to-peak), 20 Hz ~ 2,000 Hz (frequency)
Power	Power Consumption (Max.)	0.64 watt(s)
Performance	Read Speed (Max.)	up to 87 MB/s
	Write Speed (Max.)	up to 68 MB/s
	Mean Time Between Failures (MTBF)	1,000,000 hour(s)
Warranty	Warranty	Three-year Limited Warranty

Mechanical Dimensions

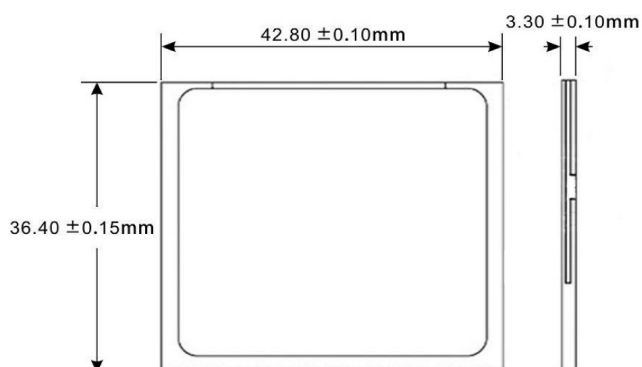

Product specifications are subject to change without notice. Pictures shown may differ from actual products. Total accessible capacity varies depending on operating environment. Due to the complexity and variety of industrial applications, Transcend cannot guarantee 100% compatibility with all platforms and under all scenarios. For special applications and environments, it is strongly suggested that you contact Transcend beforehand for clarification.