

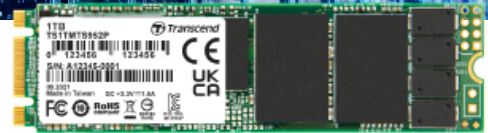

Embedded Solutions



SATA III M.2 SSDs MTS952P

Transcend's MTS952P M.2 SSD features the SATA III 6Gb/s interface, delivering superior transfer speeds. The MTS952P features the latest 3D NAND technology for high storage efficiency, 30 μ m PCB gold finger and Corner Bond technology for enhanced durability, built-in DRAM cache for fast access, an extended operating temperature range from -20°C to 75°C, and an endurance rating of 3K Program/Erase cycles for reliable operation. The built-in Power Loss Protection (PLP) further ensures data integrity in mission-critical applications.

Hardware Features

- DDR3 DRAM Cache embedded
- 30 μ m PCB gold finger
- Endurance: 3K P/E cycles (Program/Erase cycles) guaranteed
- Key components fortified by default with Corner Bond technology
- Power Loss Protection (PLP) to prevent data loss in the event of sudden power outage

Ordering Information

64GB	TS64GMTS952P
128GB	TS128GMTS952P
256GB	TS256GMTS952P
512GB	TS512GMTS952P
1TB	TS1TMTS952P

Firmware Features

- Power-saving DevSleep (Device Sleep) mode
- Dynamic thermal throttling
- Advanced Garbage Collection
- Built-in LDPC ECC (Error Correction Code) functionality
- Supports S.M.A.R.T. function to conduct health monitoring, analysis, and reporting for storage devices

Specifications

Appearance	Dimensions	80.0 mm x 22.0 mm x 3.88 mm (3.15" x 0.87" x 0.15")
	Weight	9 g (0.32 oz)
	Form Factor	M.2
	M.2 Type	2280-D5-B-M (Double-sided)
Interface	Bus Interface	SATA III 6Gb/s
Storage	Flash Type	3D NAND flash
	Capacity	64 GB / 128 GB / 256 GB / 512 GB / 1 TB
Operating Environment	Operating Voltage	3.3V±5%
	Operating Temperature	Extended Temp. -20°C (-4°F) ~ 75°C (167°F)
	Storage Temperature	-55°C (-67°F) ~ 85°C (185°F)
	Humidity	5% ~ 95%
	Shock	1500 G, 0.5 ms, 3 axis
	Vibration (Operating)	20 G (peak-to-peak), 7 Hz ~ 2000 Hz (frequency)
Power	Power Consumption (Operation)	2.3 watt(s)
	Power Consumption (Sleep)	0.4 watt(s)
Performance	Sequential Read/Write (CrystalDiskMark)	Read: up to 560 MB/s Write: up to 520 MB/s
	4K Random Read/Write (IOMeter)	Read: up to 95,000 IOPS Write: up to 85,000 IOPS
	Mean Time Between Failures (MTBF)	3,000,000 hour(s)
	Terabytes Written (TBW)	up to 1,760 TBW
	Drive Writes Per Day (DWPD)	1.61 (3 yrs)
Warranty	Certificate	CE / FCC / BSMI
	Warranty	Three-year Limited Warranty

Mechanical Dimensions

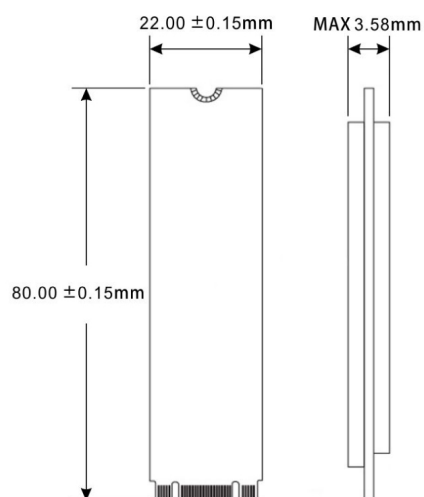

Product specifications are subject to change without notice. Pictures shown may differ from actual products. Total accessible capacity varies depending on operating environment. Due to the complexity and variety of industrial applications, Transcend cannot guarantee 100% compatibility with all platforms and under all scenarios. For special applications and environments, it is strongly suggested that you contact Transcend beforehand for clarification.