

Embedded Solutions



SD Cards

SDHC/SDXC420T

Utilizing top-quality 3D NAND Flash and rated to endure 3K P/E cycles, Transcend's SDXC/SDHC 420T memory cards combine the advantages of high performance and exceptional endurance at an affordable price, making them ideal for demanding industrial applications such as POS terminals as well as portable devices equipped with an SD memory card slot.

Hardware Features

- Compliant with SD specification 6.1
- Compliant with UHS-I
- Compliant with Video Speed Class 30 (V30)
- Compliant with Application Performance Class 2 (A2)
- Endurance: 3K P/E cycles (Program/Erase cycles) guaranteed

Firmware Features

- Built-in ECC (Error Correction Code) functionality
- Early Move
- Wear-Leveling

Ordering Information

32GB	TS32GSDC420T
64GB	TS64GSDC420T
128GB	TS128GSDC420T
256GB	TS256GSDC420T
512GB	TS512GSDC420T

Specifications

Appearance	Dimensions	24 mm x 32 mm x 2.1 mm (0.94" x 1.26" x 0.08")
	Form Factor	SD flash card
Storage	Flash Type	3D NAND flash
	Capacity	32 GB / 64 GB / 128 GB / 256 GB / 512 GB
Operating Environment	Operating Voltage	2.7V ~ 3.6V
	Drop Test	1.5m free fall
	Operating Temperature	Standard Temp. -25°C (-13°F) ~ 85°C (185°F)
	Storage Temperature	-40°C (-40°F) ~ 85°C (185°F)
	Humidity	0% ~ 95%
	Shock	Acceleration: 490 m/s ² (standard holding time: 11 ms, semi-sine wave, velocity change: 3.44 m/s)
	Vibration (Operating)	20 G (peak-to-peak), 20 Hz ~ 2,000 Hz (frequency)
Power	Power Consumption (Max.)	0.5 watt(s)
Performance	Read Speed (Max.)	up to 100 MB/s
	Write Speed (Max.)	up to 85 MB/s
	Terabytes Written (TBW)	up to 1,350 TBW
Warranty	Certificate	CE / FCC / UKCA
	Warranty	Three-year Limited Warranty

Mechanical Dimensions

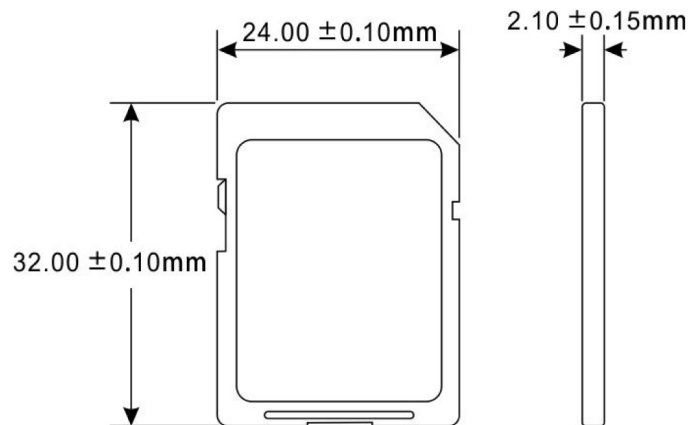

Product specifications are subject to change without notice. Pictures shown may differ from actual products. Total accessible capacity varies depending on operating environment. Due to the complexity and variety of industrial applications, Transcend cannot guarantee 100% compatibility with all platforms and under all scenarios. For special applications and environments, it is strongly suggested that you contact Transcend beforehand for clarification.